

K600

3-DIGIT NUMERATOR BLOCK



Materials:

(1-2) Numerator case:

Glass fiber reinforced polyamide.
Resistant to oils and greases.

(3) Grub screw:

K600: Steel C45
K600CIN: Stainless steel (Aisi 304).

(4) Shaft connector:

K600: Free-cutting steel.
K600CIN: Stainless steel (Aisi 303).

(4) Window:

Polymethylmethacrylate (PMMA).

(4) Number wheels:

Polyamide.

Surface finish:

(1-2-6) Smooth.
(4) Fine turned finish.
(5) Glossy, enhanced reading effect.

Colour:

(1) Case cover:

Black (RAL 9011 code 01)

(2) Case:

K600: Black (RAL 9011 code 01).

K602: Orange (RAL 2004 code 02).

K603: Grey (RAL 7035 cod. 13).

(3) Grub screw:

K600: Black-oxide treated.

K600CIN: Natural.

(4) Connector

K600: Black-oxide treated.

K600CIN: Natural.

(5) Window:

Transparent.

(6) Number wheels:

Black wheel with white numbers.



Mounting or reading position (PL)

Rotation direction (SR)

Number wheel characters:

White pad printed. Character height 4 mm approx.

Gear ratio (GR):

The gear ratio establishes which number must appear on the counter after making a full turn (360°). For example, by choosing a gear ratio of 15, after one revolution on the window you will see digits 015. The position of the decimal point will help reduce the measure, because, choosing one decimal place, the 015 becomes 01.5.

Mounting / reading position (PL):

The numerator block can be applied in four different positions. Please choose the most suitable for your application:

- P1 = Vertical, with numbers on upper side
- P2 = Vertical, with numbers on vertical side
- P3 = Horizontal, with numbers on inclined side
- P4 = Horizontal, with numbers on vertical side.

Rotation direction (SR):

- O = increase of values with clockwise rotation
- A = increase of values with counter clockwise rotation

Decimal point (PD):

The numerator block can also be chosen with decimal point. In this case, with three digits, the decimal position is available in these formats:

- PD = 0 - no decimal point indicated (000)
- PD = 1 - one digit after decimal point (00.0)
- PD = 2 - two digits after decimal point (0.00)

Base case seal:

Each numerator comes with a base case seal in black polyurethane foam. For additional orders use code K607033.

Special requests:

- Upon request a shaft reducing sleeve K605 can be supplied in black oxide treated steel, diameters available: 06 - 07 - 08.
- Upon request it can be supplied with the anti-rotation pin with backlash compensation.

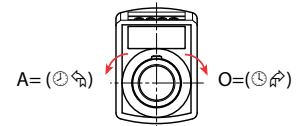
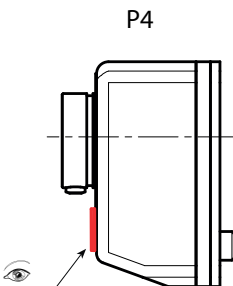
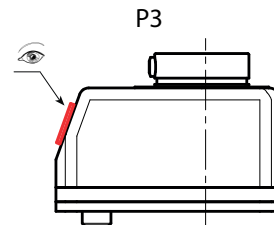
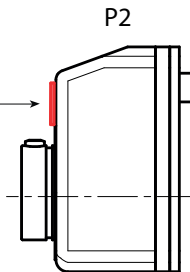
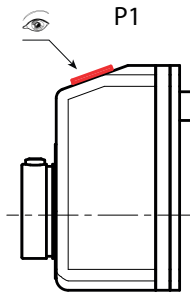

3-digit numerator block, 1 decimal place

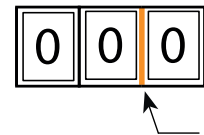

Base case seal included K60733



Reducing sleeve K605



K600

3-DIGIT NUMERATOR BLOCK



PA6

PPMA

UL94
HB

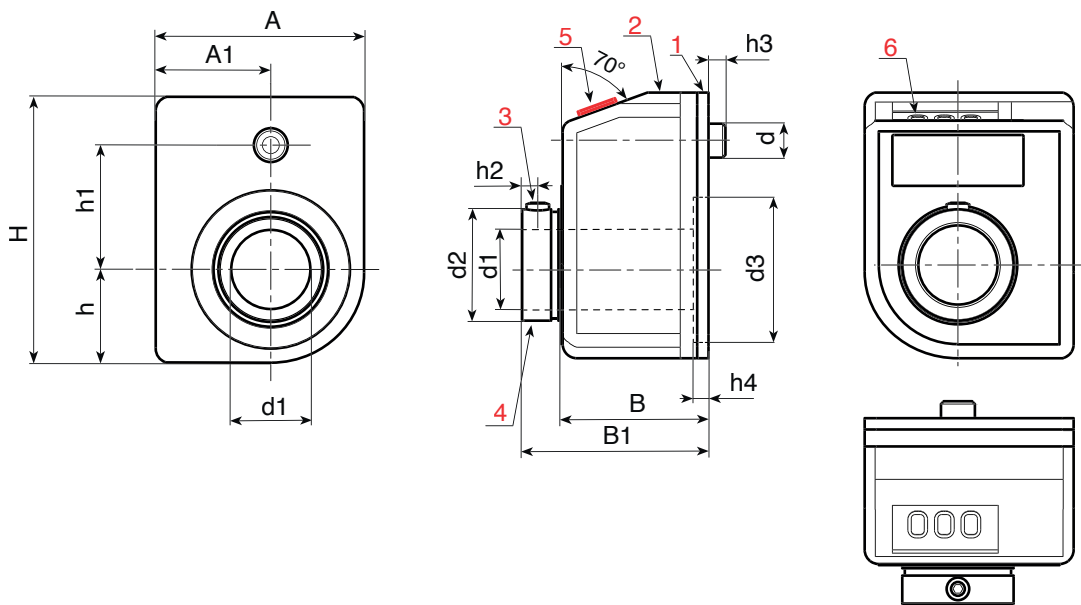

K

Options to specify in the order (GR-SR-PL-PD)

art.	H	A	h	h1	h2	h3	h4	A1	B	B1	d	d2	d3	d1H7	GR	SR	PL	DP	
K600033.TD10.....	33	22	9,3	18	2,5	5	3,4	12,7	21	26	6	13,8	16	10	7/5 - 10 - 12/5 - 15 - 17/5 - 20 - 25 - 30 - 35 - 40 - 50 - 60 - 80 - 100	O-A	P1-P2-P3-P4	0-1-2	20
K602033.TD10.....	33	22	9,3	18	2,5	5	3,4	12,7	21	26	6	13,8	16	10	7/5 - 10 - 12/5 - 15 - 17/5 - 20 - 25 - 30 - 35 - 40 - 50 - 60 - 80 - 100	O-A	P1-P2-P3-P4	0-1-2	20
K603033.TD10.....	33	22	9,3	18	2,5	5	3,4	12,7	21	26	6	13,8	16	10	7/5 - 10 - 12/5 - 15 - 17/5 - 20 - 25 - 30 - 35 - 40 - 50 - 60 - 80 - 100	O-A	P1-P2-P3-P4	0-1-2	20
K600033.TD10.....CIN	33	22	9,3	18	2,5	5	3,4	12,7	21	26	6	13,8	16	10	7/5 - 10 - 12/5 - 15 - 17/5 - 20 - 25 - 30 - 35 - 40 - 50 - 60 - 80 - 100	O-A	P1-P2-P3-P4	0-1-2	20
K602033.TD10.....CIN	33	22	9,3	18	2,5	5	3,4	12,7	21	26	6	13,8	16	10	7/5 - 10 - 12/5 - 15 - 17/5 - 20 - 25 - 30 - 35 - 40 - 50 - 60 - 80 - 100	O-A	P1-P2-P3-P4	0-1-2	20
K603033.TD10.....CIN	33	22	9,3	18	2,5	5	3,4	12,7	21	26	6	13,8	16	10	7/5 - 10 - 12/5 - 15 - 17/5 - 20 - 25 - 30 - 35 - 40 - 50 - 60 - 80 - 100	O-A	P1-P2-P3-P4	0-1-2	20

Notes: Note: For ratios "/5" the arithmetic values are not displayed.
When ordering, please insert the chosen options in the code points.

Example 1:

Example 1: for a numerator block with 3 digits (K600033) with shaft of 10mm (d1), - orange colour (K602), - with gear ratio (GR) 15; - with clockwise rotation (SR) O, - with reading position (PL) P2, - with one decimal place (PD) 1, the complete code is thus formed: K602033.TD10015OP21.

or

Example 2: for a numerator block with 3 digits (K600033) with stainless steel shaft of 10mm (d1), - black colour (K600), - with gear ratio (GR) 15; - with counterclockwise rotation (SR) A, - with reading position (PL) P3, - with two decimal places (PD) 2, the complete code is thus formed: K600033.TD10015AP32CIN.